

## A SIMPLE TECHNIQUE FOR SURFACE AREA DETERMINATION THROUGH SUPERCRITICAL CO<sub>2</sub> ADSORPTION

Mahmud Sudibandriyo

Departemen Teknik Kimia, Fakultas Teknik, Universitas Indonesia, Depok 16424, Indonesia

E-mail: msudib@che.ui.edu

---

### Abstract

The measurement of specific surface area of porous materials has long been important in physical sciences and is currently growing in importance in applied and environmental science. Numerous systems have been developed for surface area measurement by gas adsorption. Commercial systems are available which can measure a wide range of absolute surface area with relative ease. However, their cost is often prohibitive. In this study, an inexpensive apparatus for surface area measurement has been set up to be used for measuring supercritical adsorption of CO<sub>2</sub>. The Ono-Kondo Lattice model was used to represent the adsorption isotherm and to determine the surface area. The results of surface area determination using CO<sub>2</sub> adsorption combined with OK model have been compared to the numbers obtained from nitrogen BET method. For surface area determination of zeolites and activated carbons, the new method give reasonable agreement results (within 10% deviation) compared to the results obtained from nitrogen BET method. In addition, the new method also gives more reasonable results for surface area determination of coals. As known, the nitrogen BET method gives almost zero of coals' surface area. This might due to the characteristic of the coals' structure that might be change (the pores are closed) during the cooling process in nitrogen BET method. Moreover, the new method can also be used to determine the surface area of porous materials using CO<sub>2</sub> adsorption data at various temperatures without sacrificing their accuracy.

*Keywords: adsorption, carbondioxide, surface area*

---

### 1. Introduction

The measurement of specific surface area of porous materials has long been important in physical sciences and is currently growing in importance in applied and environmental science. Probably the most widely used and studied technique for surface area determination is that of gas adsorption [1]. The amount of gas adsorbed by a solid as a function of pressure is determined either gravimetrically or volumetrically and the surface area calculated from the adsorption isotherm by models such as Langmuir or BET. Numerous systems have been developed for surface area measurement by gas adsorption. Commercial systems are available which can measure a wide range of absolute surface area with relative ease. However, their cost is often prohibitive.

A common practice in determining the surface area of porous materials is using the adsorption of nitrogen gas. However, the amount of nitrogen adsorbed will depend on the temperature and consequently the calculated surface area will also depend on the temperature, which is actually unreasonable. Because this inert gas and solid interact weakly, the surface must be cooled

substantially (up to 77 K) in order to cause measurable amounts of adsorption-enough to cover the entire surface. Therefore, this measurement will need a specific container and liquid nitrogen which are not always available. Moreover, measurement at such low temperature might affect the structure of the porous materials resulting in inaccurate surface area determination. Studies showed that determination of the surface area of the coal using this method resulted in unreasonable values (near zero) [2-3].

In this study we propose to use CO<sub>2</sub> adsorption to determine the surface area. Carbon dioxide is chosen as the adsorbate gas because it is an inert gas which is easy to obtain and because of its liquid-like behavior at near room temperature. The Ono-Kondo (OK) lattice model will be used to correlate high-pressure, supercritical adsorption isotherms. This model and its temperature dependence of the parameters have been thoroughly studied that makes the model capable of consistently calculating the surface area of any porous materials at any experimentally generated adsorption isotherm [4-5]. Our intention in undertaking this work is to demonstrate the capability of a proposed simple technique for

surface area determination using supercritical CO<sub>2</sub> adsorption. Therefore, the specific objectives of proposed research are: 1) To set up a simple system that can be used for measuring the adsorption isotherm, 2) To perform the CO<sub>2</sub> adsorption isotherm measurements on several porous materials, 3) To determine the surface area of the porous materials based on the adsorption isotherm measurements using a new Ono-Kondo model, 4) To compare and study the determined surface area with the conventional values obtained from nitrogen BET measurements.

Numerous theories and models have been developed to correlate pure adsorption data to be used for surface area determination. Among them are the Langmuir model and the BET model. Recently, the Ono-Kondo (OK) lattice model was also shown capable of predicting the activated carbon surface area [4-5]. Following are brief review of relevant adsorption models used for surface area determination.

**Langmuir Model.** The most basic theory in adsorption is the Langmuir theory. This theory describes the monolayer surface adsorption on an ideal surface. Equating the rates of adsorption and desorption (evaporation), we can obtain the Langmuir isotherm written in terms of fractional loading:

$$\theta = \frac{\omega}{L} = \frac{bP}{1+bP} \quad \text{or} \quad bP = \frac{\theta}{1-\theta} \quad (1)$$

$P$  and  $L$  in Eq. (1) represents pressure and the maximum adsorption capacity (expressed in mol/gram of adsorbent). This value can be obtained from experimental isotherm data, and the surface area of the adsorbent (m<sup>2</sup>/g) can be calculated from the following expression:

$$A = L \cdot N_{av} \cdot \frac{\pi}{4} \sigma^2 \quad (2)$$

where  $N_{av}$  is avogadro's number and  $\sigma$  is the diameter of the adsorbate.

**The BET (Brunauer, Emmett and Teller) Model.** The Langmuir model is for monolayer coverage. However, in the adsorption of sub-critical adsorbates, molecules are adsorbed onto the solid surface in a layering process, and when the pressure is sufficiently high multiple layers are formed. The BET theory was first developed by Brunauer et al., in 1938, which yielded the following model.

$$\frac{\omega}{L} = \frac{CP}{(P_s - P)[1 + (C - 1)(P/P_s)]} \quad (3)$$

The BET model is widely used to determine the surface area of an adsorbent using measured nitrogen adsorption at 77K. The same formula as shown in Eq. (2) is used to calculate the surface area.

**The Lattice Theory of Adsorption (Ono-Kondo Model).** The lattice theory concept was first proposed by Ono and Kondo in 1960. Donohue et al. recently developed a more general formalism of this model, in the context of adsorption of solutes in liquid solutions [6-7]. Application of the model to pure and mixture gas adsorption on carbon substrates was also demonstrated in our previous work [4-5]. The results showed that the model was in good agreement with the experimental data studied. A general formulation and reasonable estimates for each parameter, based on accessible adsorbate-adsorbent characteristics has also been developed in our previous study. Moreover, since the model parameters are usually obtained based on adsorption isotherm, the temperature dependence of the parameters was also evaluated to make it possible to calculate the surface area of the adsorbent based on the available experimental adsorption data at any temperature.

In this approach, the equilibrium equation becomes:

$$\ln \left[ \frac{x_{ads}(1-x_b)}{x_b(1-x_{ads})} \right] + ((z_1 + 1)x_{ads} - z_0x_b) \varepsilon_{ii} / kT + \varepsilon_s / kT = 0 \quad (4)$$

where  $z_1 = 6$  and  $z_0 = 8$  for the hexagonal lattice cell.

According to the lattice theory, the Gibbs excess adsorption is defined as

$$n_i = C_i \sum_{t=1}^m (x_{i,t} - x_{i,b}) \quad (5)$$

where  $x_{i,t}$  is the fraction of adsorbed molecule  $i$  occupies the lattice cells at layer  $t$  ( $=N_{i,t}/M_t$ ) and  $x_{i,b}$  is the fraction of gas molecule  $i$  occupies the same number lattice cells as those at layer  $t$  ( $=N_{i,b}/M_t$ ). This fractional coverage can also be expressed as  $x_{i,t} = \rho_{i,t} / \rho_{i,mc}$  and  $x_{i,b} = \rho_{i,b} / \rho_{i,mc}$ , where  $\rho_{i,t}$  is the adsorbed density of component  $i$  at layer  $t$ ,  $\rho_{i,b}$  is the adsorbed density of component  $i$  at the gas phase, and  $\rho_{i,mc}$  is the adsorbed density of component  $i$  at the maximum capacity. The prefactor  $C_i$  represents the maximum capacity of the adsorbent. For pure adsorption inside the slit, according to the approach by Benard and Chahine [8], the number of layers,  $m$ , is equal to two, and Eq. (5) becomes:

$$n_{ads} = 2C (x_{ads} - x_b) = 2C \left( \frac{\rho_{ads}}{\rho_{mc}} - \frac{\rho_b}{\rho_{mc}} \right) \quad (6)$$

Here, the pre-factor  $C$  may be assumed to be a parameter taking into account the fraction of the active pores of the adsorbent and other structural properties of the adsorbent.

Based on our previous evaluation of the regressed parameter  $C$ , it appears that the value of  $C$  increases as the surface area of the adsorbent increases. This suggests that the maximum adsorption capacity,  $C$ , can

be divided into two contributions; i.e. the contribution from the adsorbent characteristic, represented by surface area ( $A$ ,  $m^2/g$ ), and the contribution from the adsorbate characteristic(s). In the previous study, we proposed the following simple relation for the maximum adsorption capacity,  $C$ :

$$C(T) = \frac{AC_a(T)}{2} \quad (7)$$

$C_a$  is the surface adsorbed-phase density ( $mmol/m^2$ ), with its value depending only on the adsorbate. Furthermore, the maximum adsorption capacity,  $C$  can be expressed in term of the following Equation [6]:

$$\ln(1/C) = \delta T - [\ln C_{a,o} + \delta T_o + \ln(A/2)] \quad (8)$$

where  $T_o$  (k) is chosen at the normal boiling point of the adsorbate (triple point for  $CO_2$ ),  $T(K)$  is the absolute temperature,  $C_{a,o}$  is the maximum surface adsorbed-phase density at  $T_o$ , and  $\delta$  is the thermal expansion coefficient of the adsorbed phase. For  $CO_2$ :  $C_{a,o} = 0.0142$   $mmol/m^2$ ;  $\delta = 0.0039$  ( $K^{-1}$ ). Therefore if  $C$  can be obtained from the experimental data, then the surface area,  $A$ , can be calculated using Eq. (8).

## 2. Methods

The methods employed in this research consist of adsorbent preparation and nitrogen BET surface area determination, adsorption apparatus set up and adsorption measurement. Detail of these activities is described in the following sections, the scheme of the research method in general is shown in a flow diagram in Figure 1.

**Adsorption Preparation.** Ten porous materials are used for the adsorption and surface area determination. They consist of two types of Zeolite, four types of Activated Carbon, and four types of coal. If the materials are obtained from the commercial market, we will use them as it is received. However, special treatment is needed if the material is obtained from the mining site. In this case, the materials will be grinded and sieved to about 20 mesh in size. The materials are

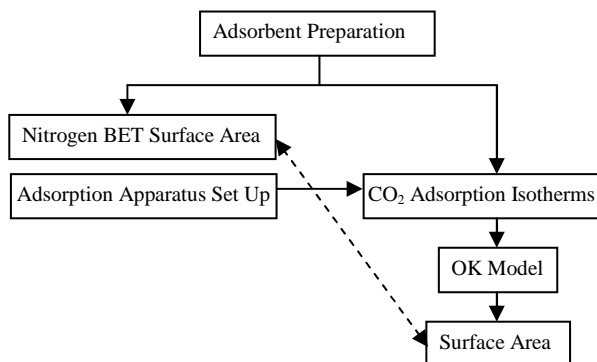

Figure 1. Schematic Diagram for Research Method

then washed using distilled water and put in the oven for four hours at 120 °C. All materials are stored in glass jars. The nitrogen BET surface area is determined using AUTOSORB - 6.

### Adsorption Apparatus Set Up and Measurements.

The experimental method use a mass balance principle, based on careful volumetric measurements. The experimental apparatus is shown schematically in Figure 2.

The apparatus is maintained in a constant temperature air bath (30 °C). The equilibrium cell (EC) has a volume of 50 cc and filled with the adsorbent to be studied. Firstly, all remaining gas in the system is evacuated using a vacuum pump and letting valves V2, V3 and V4 opened and V1 closed. V3 and V4 are then closed and the dozing cylinder is filled with helium by opening V1 and V2 until the pressure reaches  $P_i$  where V1 and V2 are then closed. The void volume,  $V_{void}$ , in the equilibrium cell was determined by injected a known quantity of helium from a dozing cylinder that has a calibrated volume (1000 cc) through opening V2 and V3 until the pressure in the dozing cylinder reaches  $P$  where V2 and V3 are then closed. The equation is

$$V_{void} = n_{He} \left( \frac{Z_{He} RT}{P} \right)_{cell} \quad (9)$$

where number of moles of helium injected into cell is

$$n_{He} = \frac{V}{RT} \left( \frac{P_i}{Z_{He,i}} - \frac{P_f}{Z_{He,f}} \right) \quad (10)$$

$V$  is the volume of the dozing cylinder, and  $P_f$  and  $P_i$  represent final and initial pressure of that cylinder respectively. The void volume was measured several times to reduce the uncertainty of this value.

For  $CO_2$  gas adsorption measurements, a given quantity of  $CO_2$  gas,  $n_{inj}$ , was first injected into the cell. The procedure and the amount was determined by an equation

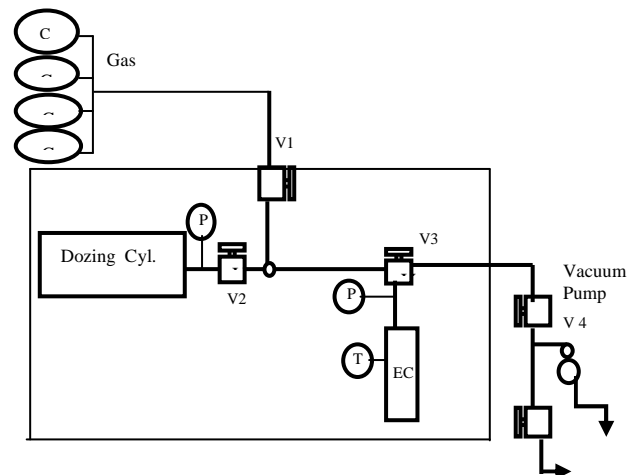

Figure 2. Schematic Graph of the Experimental Apparatus

analogous to Eq. (10), above. The condition of equilibrium was identified as the condition at which the pressure in the equilibrium cell stabilized. The amount of unadsorbed gas,  $n_{unads}$ , was determined using the following expression:

$$n_{unads} = \left( \frac{PV_{void}}{Z_{gas}RT} \right)_{cell} \quad (11)$$

where the pressure  $P$  was measured after equilibrium was reached in the cell. The amount of adsorbed gas,  $n_{ads}$ , was calculated by difference as

$$n_{ads} = n_{inj} - n_{unads} \quad (12)$$

The above steps were repeated at sequentially higher pressures (up to 60 bar) to yield a complete adsorption isotherm. It should be noted that the obtained experimental data are in Gibbs adsorption which exhibits a maximum isotherm at high pressures [9].

A high-precision electronic manometer pressure gauges with direct read-out is attached both in the dosing cylinder and equilibrium cell. The helium and CO<sub>2</sub> gases used in this work were obtained from commercial market with purities of at least 99.9% and will be used as received.

As indicated by Eqs. (9) through (11), accurate gas-phase compressibility ( $Z$ ) factors are required for helium and carbon dioxide to properly analyze the experimental data. The compressibility factors for pure CO<sub>2</sub> were determined from highly accurate equations of state. For void volume determination, the helium compressibility factor is given by Hall [9]:

$$Z_{He} = 1 + (0.001471 - 0.000004779T + 0.00000004927T^2) / P \quad (13)$$

where  $T$  is in Kelvins and  $P$  is in atmospheres. This expression is based on the experimental data from National Bureau of Standards Technical Note 631 for helium.

### 3. Results and Discussion

**BET Surface Area of Porous Materials.** Ten porous materials were used in this experiment. The Nitrogen BET surface areas of some materials were obtained from literature, and some other materials' surface areas were determined during this experiment. For the last case, the materials were grinded and sieved to about 100 mesh in size, then washed using distilled water and put in the oven for four hours at 120 °C, before their surface areas were measured using nitrogen BET-AUTOSORB-6. The materials include two types of Zeolite, four types of Activated Carbon, and four types of coal. The following Table shows the results of nitrogen BET surface area obtained from literature and AUTOSORB-6 of those ten materials.

**Table 1. Nitrogen-BET Surface Area for Porous Materials**

No	Materials	Surface Area (m <sup>2</sup> /g)
1	Zeolite 1	494
2	Zeolite 2	51
3	Activated Carbon 1 (Calgon)	900 [9]
4	Activated Carbon 2 (Local)	1065
5	Activated Carbon 3 (Synthesized)	550
6	Activated Carbon 4 (Synthesized)	650
7	Coal 1 (Sumatra)	0
8	Coal 2 (Kalimantan)	0
9	Coal 3 (Illinois No. 6)	30 [2]
10	Coal 4 (Pocahontas)	0 [2]

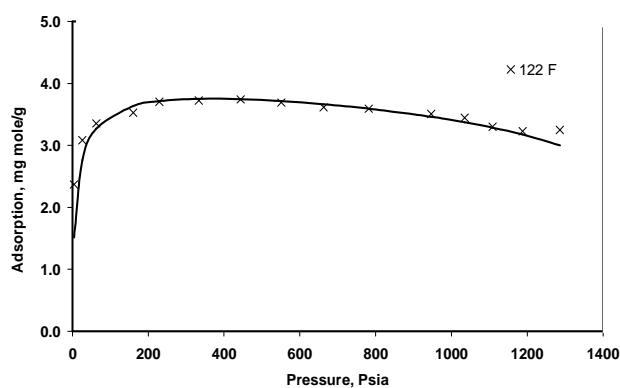

**Figure 3. CO<sub>2</sub> Adsorption on Zeolite Linde-A5**

**CO<sub>2</sub> Adsorption Results and Determination of Surface Area using OK Model.** CO<sub>2</sub> adsorption data on three different adsorbents (Zeolites, Activated Carbons, and Coals) were used and fitted with the OK model to obtain their surface areas. Some of the adsorption data were obtained from literature and some others were obtained by conducting CO<sub>2</sub> adsorption experiment using our new apparatus set up.

**CO<sub>2</sub> Adsorption on Zeolites.** Figure 3 shows the CO<sub>2</sub> Adsorption on Zeolite (Linde 5A) at 50 °C, conducted by Wakasugi [10]. The information of its Nitrogen BET Surface area is 494 m<sup>2</sup>/g. The solid line in Figure 3 represents the fitted OK model using four model parameters; i.e:  $\rho_{mc} = 23.5$  mol/l;  $\varepsilon/k = 81.6$  K;  $\varepsilon_{sf}/k = -2500$  K, and  $C = 2.06$  mmol/g. As shown in the figure, the model can represent the experiment data quite well within 2.4% AAPD (Average Absolute Percent Deviation). Parameter C in the model can be used to calculate the surface area of Zeolite using Eq. (8). The surface area obtained using this method is 438 m<sup>2</sup>/g, which is not significantly different from the one obtained using nitrogen BET surface area.

Figure 4. shows the CO<sub>2</sub> Adsorption on Zeolite (Local) at 30 °C, conducted in our Laboratory using new experiment apparatus set up. The Nitrogen BET Surface area obtained using AUTOSORB-6 is 51 m<sup>2</sup>/g. The solid line in Figure 4 represents the fitted OK model using four model parameters as described above. The surface area obtained by evaluating the C parameter using in this method is 59 m<sup>2</sup>/g, which is also not significantly different from the one obtained using nitrogen BET surface area.

**CO<sub>2</sub> Adsorption on Activated Carbons.** Figure 5. shows the CO<sub>2</sub> adsorption on Calgon-Activated Carbon at 45 °C, conducted by Sudibandriyo [9]. The information from the company saying that its surface area is about 900 m<sup>2</sup>/g. The solid line in Figure 5 represents the fitted OK model using four model parameters; i.e:  $\rho_{mc} = 23.5 \text{ mol/l}$ ;  $\varepsilon/k = 84.3 \text{ K}$ ;  $\varepsilon_{sf}/k = -1710 \text{ K}$ , and  $C = 4.50 \text{ mmol/g}$ . As shown in the figure, the model can represent the experiment data quite well within 3.4% AAPD (Average Absolute Percent Deviation). Parameter C in the model can be used to calculate the surface area of Activated Carbon using Eq. (8). The surface area obtained using this method is 935 m<sup>2</sup>/g, which is not significantly different from the information obtained from the company.

Figure 6. shows the CO<sub>2</sub> Adsorption on two Activated Carbons (Local and Synthesized) at 35 °C, conducted in our Laboratory using new experiment apparatus set up. The Nitrogen BET Surface areas obtained using AUTOSORB-6 are 1065 and 550 m<sup>2</sup>/g for Local (High Surface Area) and Synthesized (Low Surface Area) Activated Carbon, respectively. The solid line in Figure 6 represents the fitted OK model using four model parameters as described above. As shown in the figure, the model can represent the experiment data quite well in higher pressure, but in the lower pressure the experimental data do not fit very well with the model. However by minimizing the error, the surface area can be obtained by evaluating the C parameter. Using this method the surface areas are obtained to be 1038 and 494 m<sup>2</sup>/g for high and low surface area types of activated

carbons, respectively. The results show reasonably agreement with the surface area using nitrogen BET surface area (with deviation up to 10%).

**CO<sub>2</sub> Adsorption on Coals.** Figure 7. shows the CO<sub>2</sub> Adsorption on Pocahontas and Illinois No. 6 Coals at 55 °C, conducted by Sudibandriyo [11]. The nitrogen BET surface areas obtained from literature [2] are 0 and 30 m<sup>2</sup>/g for Pocahontas and Illinois No 6 coals respectively. The solid line in Figure 14 represents the

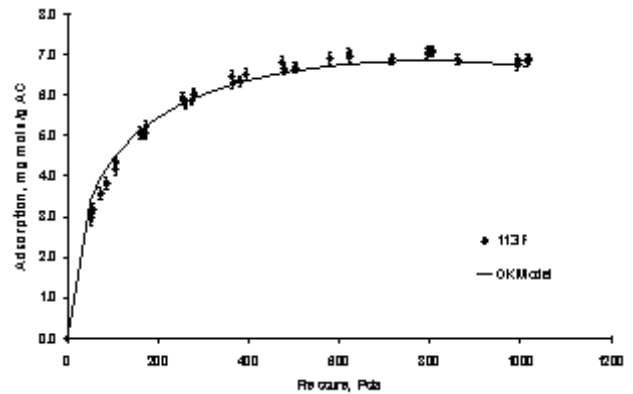

Figure 5. Experiment (♦) and OK Model (—) of CO<sub>2</sub> Adsorption on Calgon – Activated Carbon

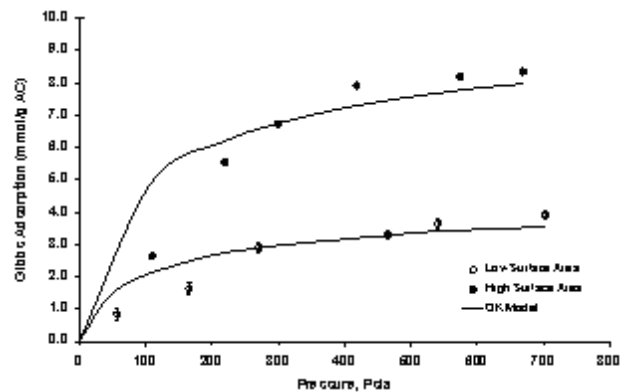

Figure 6. CO<sub>2</sub> Adsorption on Local– Activated Carbon On Low Surface Area (○) Compared to High Surface Area (♦)

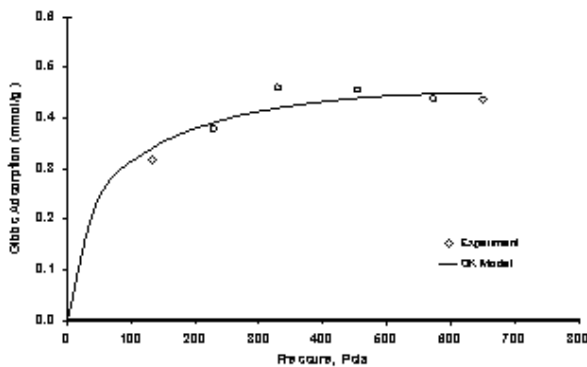

Figure 4. Experiment (◇) and OK Model (—) of CO<sub>2</sub> Adsorption on Local Zeolite

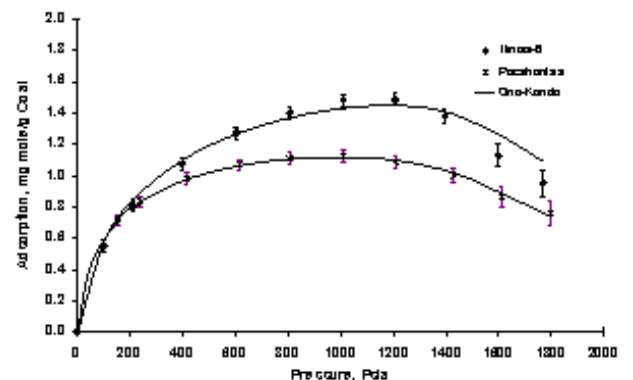

Figure 7. CO<sub>2</sub> Adsorption on Illinois-6 (♦) and Pocahontash (x) Coals

**Table 2. Comparisons of Surface Area Determined Using CO<sub>2</sub> Adsorption–OK Model and N<sub>2</sub>–BET Methods**

Adsorbents	Temp. of CO <sub>2</sub> Adsorption (°C)	OK – Model Surface Area (m <sup>2</sup> /g)	N <sub>2</sub> – BET Surface Area (m <sup>2</sup> /g)
1 Zeolite Linde 5A	50	438	494
2 Zeolite (Local)	30	59	51
3 Activated Carbon (Calgon)	45	935	900
4 Activated Carbon (Local)	30	1038	1065
5 Activated Carbon (Local)	30	494	550
6 Coal (Pocahontas)	55	173	0
7 Coal (Illinois No 6)	55	261	30

fitted OK model using four model parameters; i.e:  $p_{mc} = 23.5$  mol/l;  $\varepsilon/k = 84.3$  K;  $\varepsilon_{sf}/k = -1540$  K (Pocahontas),  $\varepsilon_{sf}/k = -1250$  K (Illinois No. 6), and  $C = 0.798$  mmol/g (Pocahontas),  $C = 1.204$  mmol/g (Illinois No. 6). As shown in the figure, the model can represent the experiment data well within 1.8% and 5.0% AAPD for Pocahontas and Illinois No. 6 coals respectively. The surface areas obtained using Eq. (8) are 173 and 261 m<sup>2</sup>/g for Pocahontas and Illinois No. 6 coals respectively. These results give more reasonable numbers of surface areas than the numbers obtained from nitrogen BET determination method.

#### 4. Conclusion

A set of an inexpensive apparatus has been developed and set up in this research project, which provide a new simple method capable of determining the surface area

of porous materials via measurement of CO<sub>2</sub> isotherm adsorption. The OK model is capable of representing the CO<sub>2</sub> isotherm adsorption data within 5% deviation in average. The combined CO<sub>2</sub> isotherm adsorption and OK Model can be used to determine the surface areas of porous materials (evaluated, i.e. Zeolites, Activated Carbons, and Coals) with reasonable accuracy results. The new method can be used to determine the surface area of porous materials using CO<sub>2</sub> adsorption data at various temperatures without sacrificing their accuracy.

#### References

- [1] J.U. Keller, Gas Adsorption Equilibria: Experimental Methods and Adsorption Isotherm. <http://www.springeronline.com>. 2005.
- [2] H. Gan, S.P. Nandi, P.L. Walker Jr., Fuel 51 (1972) 272.
- [3] S. Mulyati, Skripsi Sarjana, Departemen Teknik Kimia FT, Universitas Indonesia, Indonesia, 2006.
- [4] M. Sudibandriyo, Final Report for Osaka Gas Foundation of International Cultural Exchange, PPST, Universitas Indonesia, Indonesia, 2005.
- [5] M. Sudibandriyo, Jurnal Teknologi 4 (2007) 309.
- [6] T. Hocker, G.L. Aranovich, M.D. Donohue, J. of Colloid and Interface Sci. 211 (1999) 61.
- [7] T. Hocker, G.L. Aranovich, M.D. Donohue, J. Chem. Phys. 111 (3) (1999) 1240.
- [8] P. Benard, R. Chahine, Langmuir 13 (2001) 808.
- [9] M. Sudibandriyo, Z. Pan, J.E. Fitzgerald, R.L. Robinson Jr., K.A.M. Gasem, Langmuir 19(13) (2003) 5323.
- [10] Y. Wakasugi, S. Ozawa, Y. Ogino, J. of Colloid and Interface Sci. 79 (1981) 399.
- [11] M. Sudibandriyo, Ph.D Dissertation, School of Chemical Engineering, Oklahoma State University, USA, 2003.